

## 1T7814EL | OZ Stand Alone Recessed Recessed LED floodlights

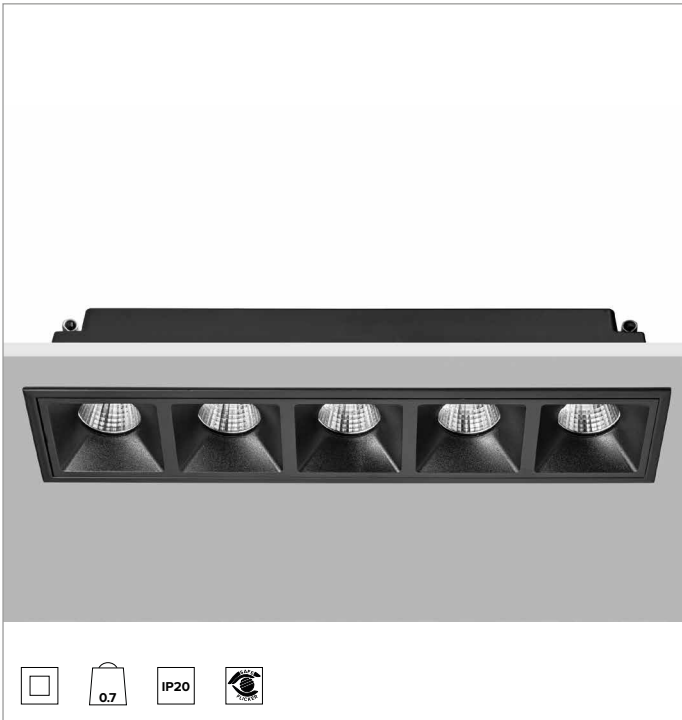

		2700K	H(m)	D(m)	Emax(lx)	
		Ra90		50°		
Fixture Power	33W	1	0.93	5130		
Source Flux	4090lm	2	1.85	1282		
Fixture Flux	3164lm	3	2.78	570		
Efficacy	96lm/W	4	3.71	321		
TS1196	Imax=1254cd/klm	Imax	5130cd	5	4.64	205

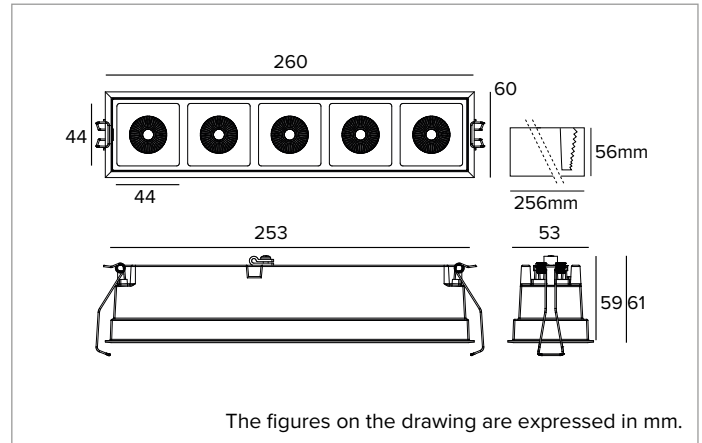

### SOURCE

High efficiency Chip on Board LED Ra90.

**Energy efficiency class:** E

**Nominal power:** 29W

**Nominal flux:** 4090lm

**Colour rendering index:** 90

**Rf:** 92

**Rg:** 99

**CCT nominal:** 2700K

**SDCM:** 2

**Lifetime (L80/B10):** >50000h tq +25°C

### ILLUMINOTECHNICAL CHARACTERISTICS

MWFL optic. Anodised aluminium reflector and black polycarbonate frame. The light is suitable for installation in work environments UGR<17 (EN12464-1).

**Optic:** REFLECTOR

**Beam angles:** MWFL

**Optical efficiency:** 77%

**Fixture flux:** 3164lm

**Luminous efficacy:** 96lm/W

**Photobiological safety:** Compliant with RG1 low risk group

### MECHANICAL CHARACTERISTICS

Black painted die-cast aluminium body. 5X Large version.

**Colour and finish:** Deep black

**Dimensions:** Ax B=260x60mm

**Weight:** 0.7Kg

**Version:** 5X

**Degree of protection:** IP20

### ELECTRICAL CHARACTERISTICS

Complete with an electronic ON-OFF driver. Luminaire compliant with EN 60598-2-22 for power supply from a centralised emergency system CPSS (Central Power Supply System), not incorporated in the luminaire - high risk areas excluded. The default power and flux are 100% in AC and 100% in DC.

**Fixture Power:** 33W

**Power supply:** 220-240Vac 50/60Hz

**Insulation Class:** CLASS 2

**Type of driver / Control:** ON-OFF

**Driver included:** YES

**Class F:** YES

**SAFE FLICKER:** PstLM=<1 and SVM=<0.4 (IEC TR 61547-1 and IEC TR 63158), to ensure a more comfortable and safe light

**Ambient temperature:** 0°C / +25°C

### INSTALLATION

Quick fastening system with springs for installation in false ceilings from 0 to 30mm.

### NOTES

110-277Vac version available on request.

### WARRANTY

5 years.

### WARNING

Luminaire designed for disposal/recycling at end-of-life. Replaceable (LED only) light source by a professional. Replaceable control gear by a professional.

*Due to the technological evolution of the electronic components, the data provided may be updated, and as such, confirmation must be requested during the order process.*

*Luminous flux and power supply have +/-10% tolerances with respect to the indicated value. tq +25°C (CIE 121).*

*We reserve the right to make technical changes.*

Targetti Sankey S.r.l.  
Via Pratese, 164  
50145 Firenze - Italy  
Tel: +39 055 37911  
targetti.com  
targetti@targetti.com

CCIAA Firenze  
Share Capital:  
€ 500.000,00  
VAT N. (IT):  
01537660480  
R.E.A: FI-275656

**TARGETTI**

## 1T7814EL | OZ Stand Alone Recessed Recessed LED floodlights

### Accessories

#### Emergency Kit



Code

**A059**

Emergency kit composed of an inverter a LiFePO4 battery and a LED Green indicator. Allows permanent EP emergency use of the fixture it is connected to.

The 1h or 3h autonomy can be selected by configuring the fixture.

The batteries take 12h to completely recharge.

LED Green indicator wired to the inverter through single-core cables L= 800mm.

Emergency kit for fixtures that comply with EN 60598-2-22 standard, high risk areas excluded.

Battery size 160x54x30 mm.

Inverter size 165x40x25 mm.

*Due to the technological evolution of the electronic components, the data provided may be updated, and as such, confirmation must be requested during the order process.*

*Luminous flux and power supply have +/-10% tolerances with respect to the indicated value. tq +25°C (CIE 121).*

*We reserve the right to make technical changes.*

Targetti Sankey S.r.l.  
Via Pratese, 164  
50145 Firenze - Italy  
Tel: +39 055 37911  
targetti.com  
targetti@targetti.com

CCIAA Firenze  
Share Capital:  
€ 500.000,00  
VAT N. (IT):  
01537660480  
R.E.A: FI-275656

**TARGETTI**